

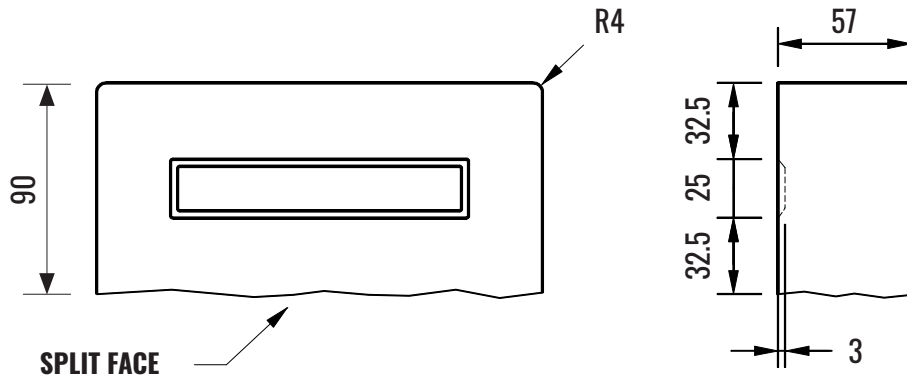

57 mm (2 in.) SPLIT FACE BRICK BLOCK

STRETCHER BRICK



CORNER BRICK

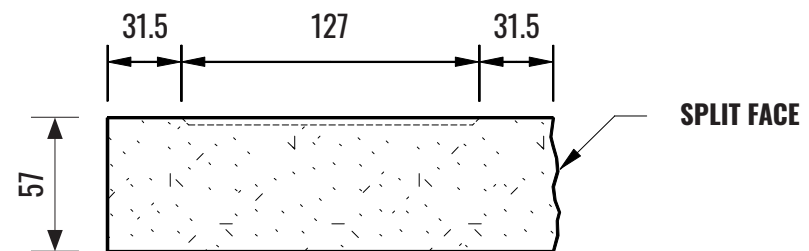
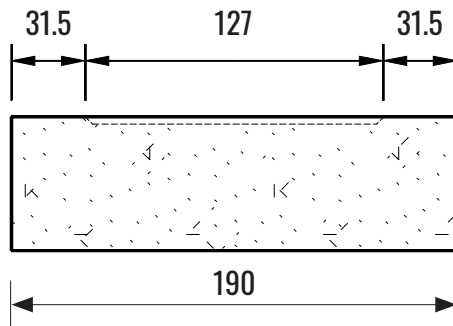
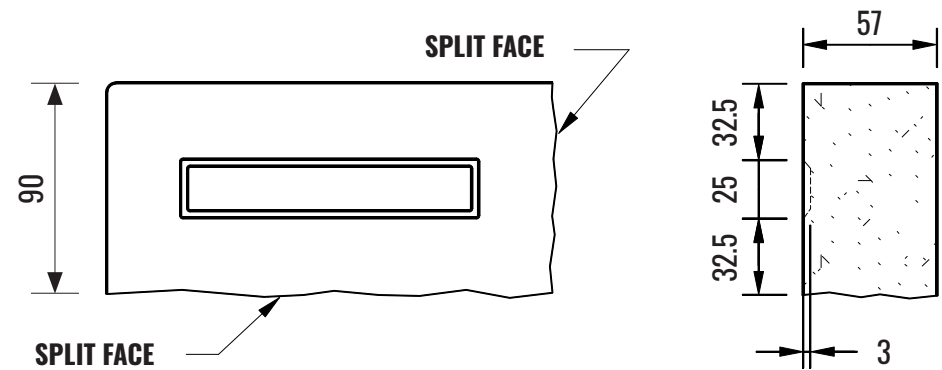

STANDARD COLOURS

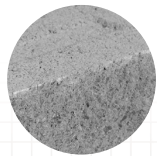

NATURAL GREY

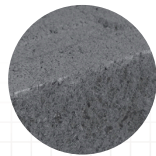

CHARCOAL

AVAILABLE ON REQUEST

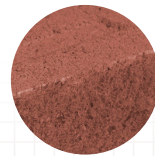

RED

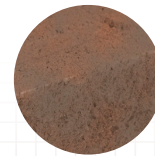

CASEY-MIX

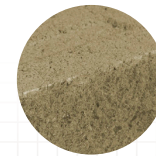

BUFF

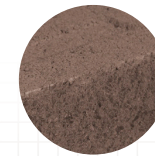

BROWN

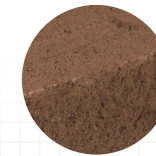

TAN

PLEASE NOTE: Products are made from natural material sources and therefore color variation and efflorescence may occur.

PACKAGING:

Pieces Per Pallet: 600
 Weight Per Piece: 2.14 kg (4.7 lbs)
 Weight Per Pallet: 1284 kg (2830 lbs)
 Unit Coverage: 0.117 Sq. Ft. (70.2 Sq. Ft. per pallet)

DIMENSIONAL TOLERANCES:

Compliant with CSA A165.2 Concrete Brick Grade 1
 Length: -2 to +2 mm
 Width: -2 to +2 mm *not including
 Height: -2 to +2 mm rough split face

PHYSICAL PROPERTIES:

Compliant with CSA A165.2 Concrete Brick Grade 1
 Compressive Strength: Min. 25 MPa @ 28 Days
 Absorption (%): 8.0 % Maximum @ 28 Days
 Classification: A165.2 3.3 Grade 1

