

TOP VIEW

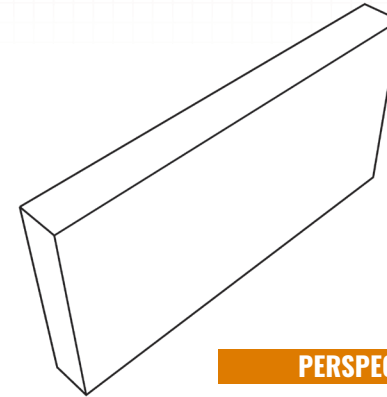

PERSPECTIVE VIEW

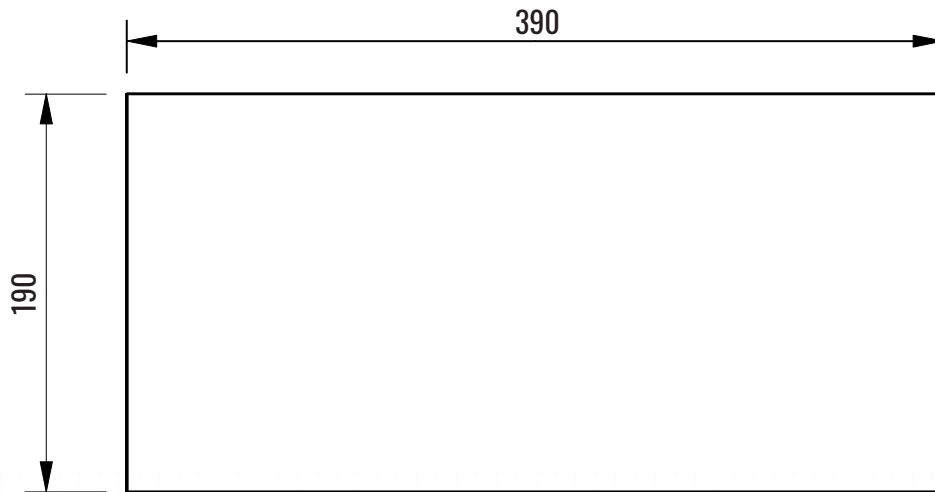

FRONT X-SECTION

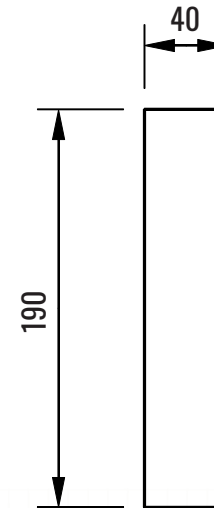

END X-SECTION

PLEASE NOTE: Products are made from natural material sources and therefore color variation and efflorescence may occur.

PACKAGING:

Pieces Per Pallet: 240
Weight Per Piece: 6.82 kg (15 lbs)
Weight Per Pallet: 1636 kg (3600 lbs)
Coverage Per Piece: 0.8 sq. ft

DIMENSIONAL TOLERANCES:

Meets the requirements of CSA A165.1 Concrete Masonry
Length: -3 to +3 mm
Width: -2 to +2 mm
Height: -3 to +2 mm

PHYSICAL PROPERTIES:

Meets the requirements of CSA A165.1 Concrete Masonry
Compressive Strength: Min 15 MPa @ 28 Days
Absorption (%): 8.0 % Maximum @ 28 Days

