

TOP VIEW

SEE DETAIL "A"

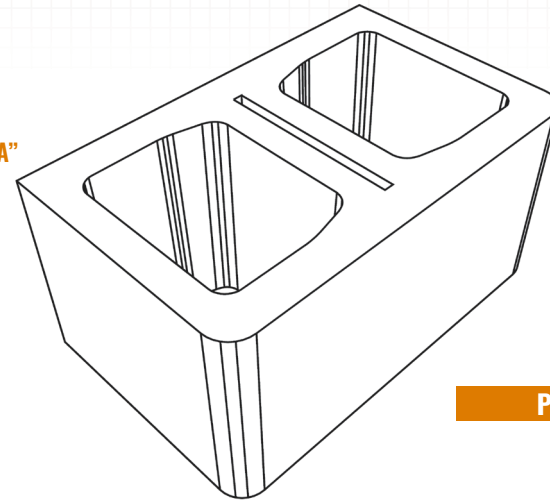

PERSPECTIVE VIEW

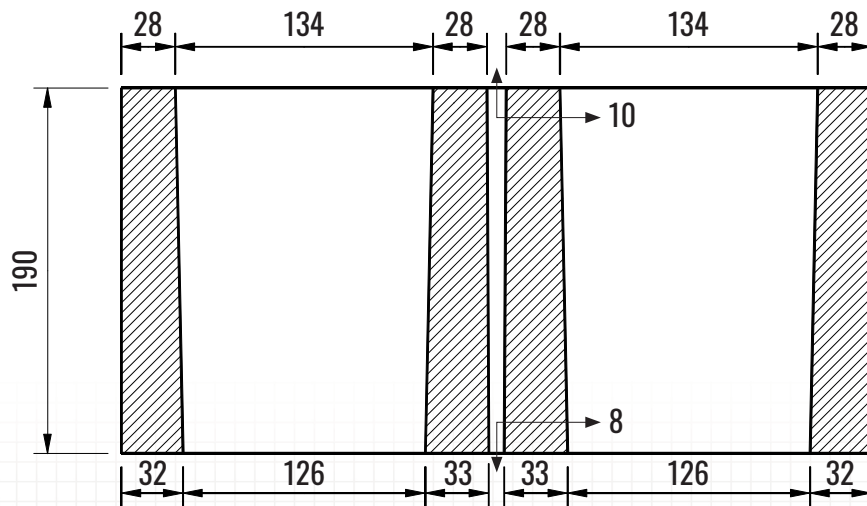
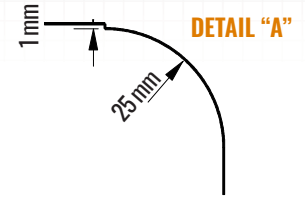

FRONT X-SECTION

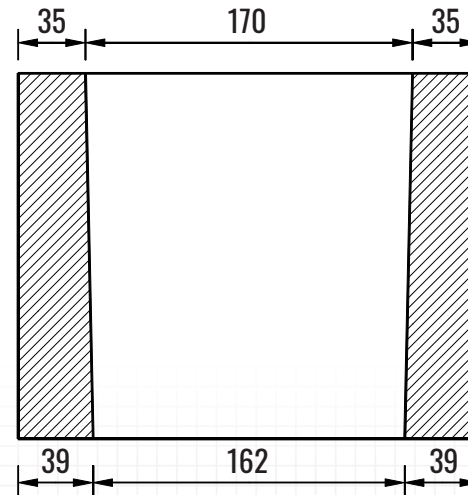

END X-SECTION

PLEASE NOTE: Products are made from natural material sources and therefore color variation and efflorescence may occur.

PACKAGING:

Pieces Per Pallet: 60
 Weight Per Piece: 23.18 kg (51 lbs)
 Weight Per Pallet: 1336 kg (2940 lbs)
 Coverage Per Piece: 0.8 sq. ft (48 sq. ft per pallet)

DIMENSIONAL TOLERANCES:

Meets the requirements of CSA A165.1 Concrete Masonry
 Length: -3 to +3 mm
 Width: -2 to +2 mm
 Height: -3 to +2 mm

PHYSICAL PROPERTIES:

Meets the requirements of CSA A165.1 Concrete Masonry
 Compressive Strength: Min 15 MPa @ 28 Days
 Absorption (%): 8.0 % Maximum @ 28 Days

