

TOP VIEW

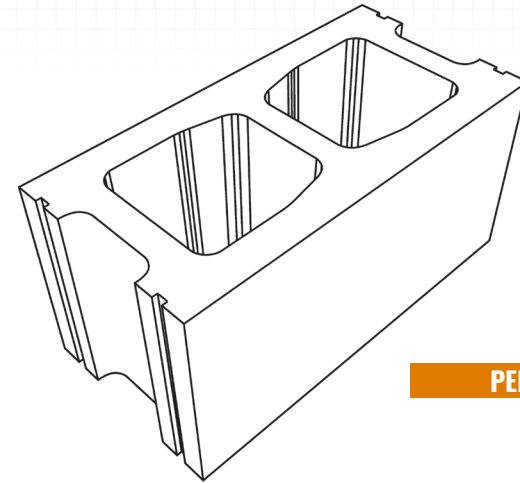

PERSPECTIVE VIEW

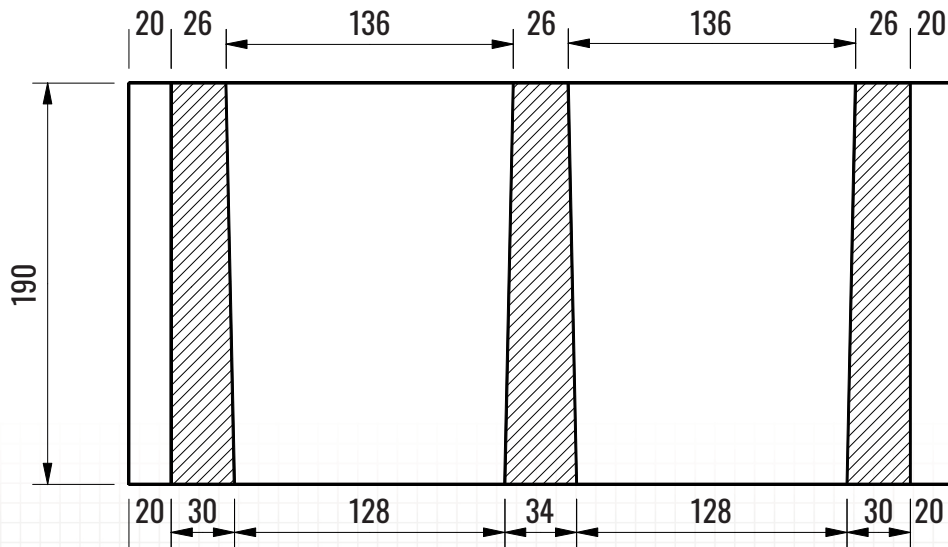

FRONT X-SECTION

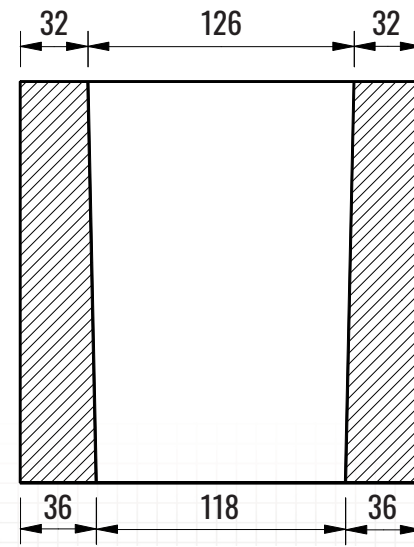

END X-SECTION



**PLEASE NOTE:** Products are made from natural material sources and therefore color variation and efflorescence may occur.

### PACKAGING:

Pieces Per Pallet: 75  
 Weight Per Piece: 17.27 kg (38 lbs)  
 Weight Per Pallet: 1295 kg (2850 lbs)  
 Coverage Per Piece: 0.8 sq. ft (60 sq. ft per pallet)

### DIMENSIONAL TOLERANCES:

Meets the requirements of CSA A165.1 Concrete Masonry  
 Length: -3 to +3 mm  
 Width: -2 to +2 mm  
 Height: -3 to +2 mm

### PHYSICAL PROPERTIES:

Meets the requirements of CSA A165.1 Concrete Masonry  
 Compressive Strength: Min 15 MPa @ 28 Days  
 Absorption (%): 8.0 % Maximum @ 28 Days