

TOP VIEW

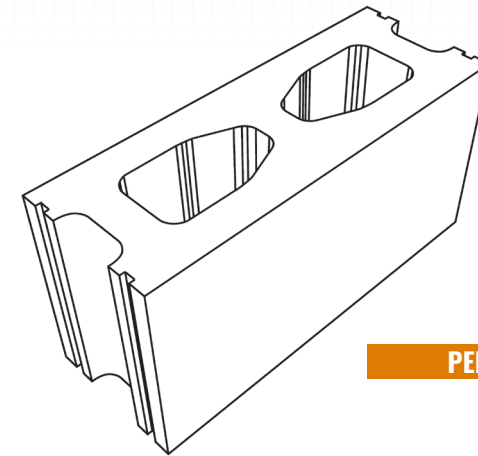

PERSPECTIVE VIEW

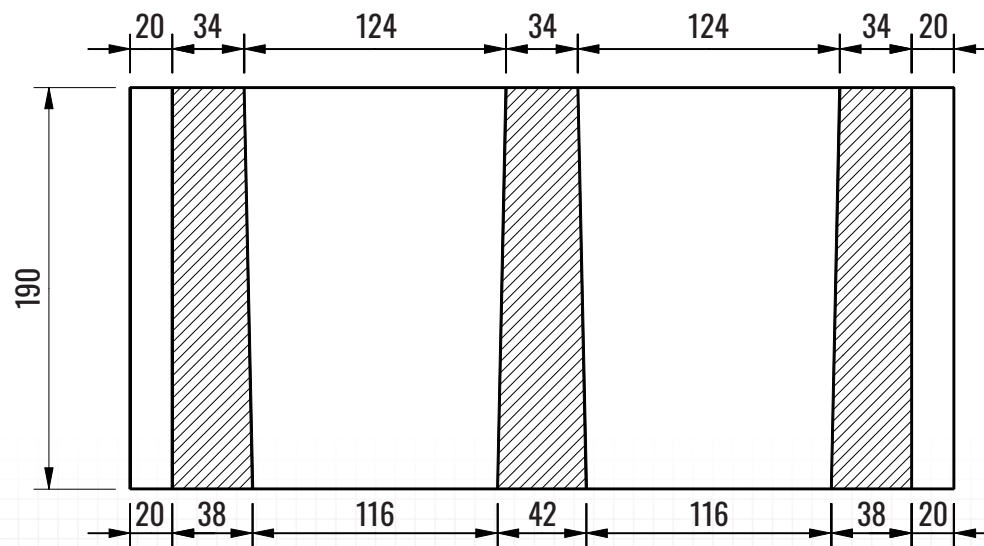

FRONT X-SECTION

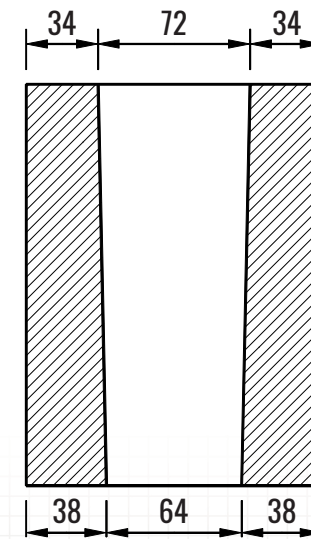

END X-SECTION

PLEASE NOTE: Products are made from natural material sources and therefore color variation and efflorescence may occur.

PACKAGING:

Pieces Per Pallet: 75
 Weight Per Piece: 17.73 kg (39 lbs)
 Weight Per Pallet: 1330 kg (2925 lbs)
 Coverage Per Piece: 0.8 sq. ft (60 sq. ft per pallet)

DIMENSIONAL TOLERANCES:

Meets the requirements of CSA A165.1 Concrete Masonry
 Length: -3 to +3 mm
 Width: -2 to +2 mm
 Height: -3 to +2 mm

PHYSICAL PROPERTIES:

Meets the requirements of CSA A165.1 Concrete Masonry
 Compressive Strength: Min 15 MPa @ 28 Days
 Absorption (%): 8.0 % Maximum @ 28 Days

